



PyLoN:100

1340 x 100



The PyLoN[®]:100 is a controllerless, cryogenically-cooled CCD camera designed for quantitative scientific spectroscopy applications demanding the highest possible sensitivity. Princeton Instruments has completely redesigned the industry-leading Spec-10 family of cameras to eliminate the external controller, increasing experimental flexibility while further improving the ultralow noise electronics. Liquid nitrogen cooling virtually eliminates dark current, while PyLoN's indium metal seals enhance its vacuum longevity. PyLoN:100 cameras provide dual amplifiers and software-selectable gains that permit operation in either high-sensitivity mode (Raman or single molecule spectroscopy) or high-capacity mode (fluorescence spectroscopy), and are fully supported by LightField[®], powerful 64-bit data acquisition software, and IntelliCal[™] wavelength and intensity calibration packages. PyLoN features ADC rates of up to 4 MHz, with digital bias stabilization and correlated double sampling for decreased read noise and improved linearity, and Princeton Instruments' exclusive eXcelon[®] technology, delivering the highest responsivity from the UV to the NIR while suppressing etaloning that occurs in standard back-illuminated CCDs.

FEATURE	BENEFITS
eXcelon technology	Increases detector sensitivity while suppressing etalon interference fringes observed in the NIR with conventional back-illuminated devices
1340 x 100 imaging array, 20 μm x 20 μm pixels	Proprietary format with 2 mm height for rapid spectral acquisition; 20 μm pixel size offers the optimal combination of high resolution and dynamic range
Cryogenic cooling to -120°C using liquid nitrogen	Effectively eliminates dark charge, permitting acquisition times from milliseconds to hours
Single fused silica vacuum window	Minimizes reflection losses from UV - IR; Optional AR coatings & wedge windows are available
Optional UV phosphor coatings	Extends CCD sensitivity to below 200 nm (not available for eXcelon cameras)
TTL input and output	Allows external control of and triggering by lasers or timing generators
Dual amplifiers with software-selectable system gains	High sensitivity amplifier reduces read noise floor for weak signals; High capacity amplifier increases dynamic range
Kinetics & Custom Sensor modes	Standard on all PyLoN cameras, Kinetics mode allows microsecond-resolved kinetic spectral acquisition, while Custom Sensor mode increases control over the camera readout, permitting spectral rates of over 1000 fps.
Data acquisition rates of 50 kHz to 4 MHz	Up to 4X as fast as its predecessor - Choose low speed digitization to reduce noise, or high speed for rapid spectral acquisition
Optional end-on and all-directional dewar mounts	Allows for easy and flexible camera positioning
GigE data interface	Reliable data transmission over 50 m for remote operation
Optional: LightField (for Windows 7, 64-bit) or WinSpec (for Windows XP/7, 32-bit)	Flexible software packages for data acquisition, display and analysis. LightField offers intuitive, cutting edge user interface, IntelliCal [™] , hardware time stamping & more
PICAM/PVCAM SDKs	Universal programming interface for software developers

Applications:

Raman Spectroscopy, Absorbance, Emission, Fluorescence and Reflectance Spectroscopy

SPECIFICATIONS

	 PyLoN:100BR_eXcelon	PyLoN:100BR	 PyLoN:100B_eXcelon	PyLoN:100B	PyLoN:100F
Features	Back-illuminated, deep depletion CCD with eXcelon technology. Highest average QE from the UV to the NIR with negligible etaloning.	Back-illuminated, deep depletion CCD. High QE in the NIR with minimal etaloning.	Back-illuminated CCD with eXcelon technology. Enhanced QE in the UV and the NIR with low etaloning.	Back-illuminated CCD. Highest QE in the visible with low dark current. Subject to etaloning in the NIR.	Front-illuminated CCD. Affordable technology for moderate light level applications. No etaloning.
Typical dark current @ -120°C (e ⁻ /pixel/hour) *	2	2	< 1	< 1	< 1
Typical System read noise @100 kHz @2 MHz	3 e ⁻ rms 12 e ⁻ rms				
Operating temperature	80°C to -120°C with ±0.05°C thermostating precision				
CCD format	1340 x 100, 20 μm x 20 μm pixels with 100% fill factor				
Imaging area	26.8 x 2.0 mm (optically centered)				
Spectrometric well capacity: High Sensitivity High Capacity	200 ke ⁻ (typical) > 700 ke ⁻ (typical)				
ADC rates	50, 100, 200, 500 kHz and 1, 2, 4 MHz; 16 bits				
Non-linearity	< 1% @ 100 kHz				
Vertical shift times	8 - 20 μsec/row (programmable)				
Analog gain (typical)	0.75, 1.5, 3.0 e ⁻ /ADU (high sensitivity); 3, 6, 12 e ⁻ /ADU (high capacity)				
Data interface	Gigabit Ethernet				
I/O signals	Trigger In, TTL Out, Readout Monitor, Expose Monitor, Shutter Monitor				
Optical mount	Princeton Instruments' Acton spectrometer adapter with optional 40 mm shutter				
Operating environment	+5°C to +30°C, non-condensing atmosphere				
Certification	CE				
Dimensions Weight	14.6 inches (371 mm) x 8.2 inches (208 mm) x 10.5 inches (267 mm) (H x W x D) Approximately 10 lbs (4.5 kg)				

* Limited by cosmic ray background

All specifications are subject to change.

SPECTRAL RATES

@ 4 MHz Full Frame	24 fps
@ 100 kHz Full Vertical Bin	70 fps
@ 4 MHz Full Vertical Bin	750 fps
@ 4 MHz, 20 rows (0.4 mm high) Custom Chip	1700 fps

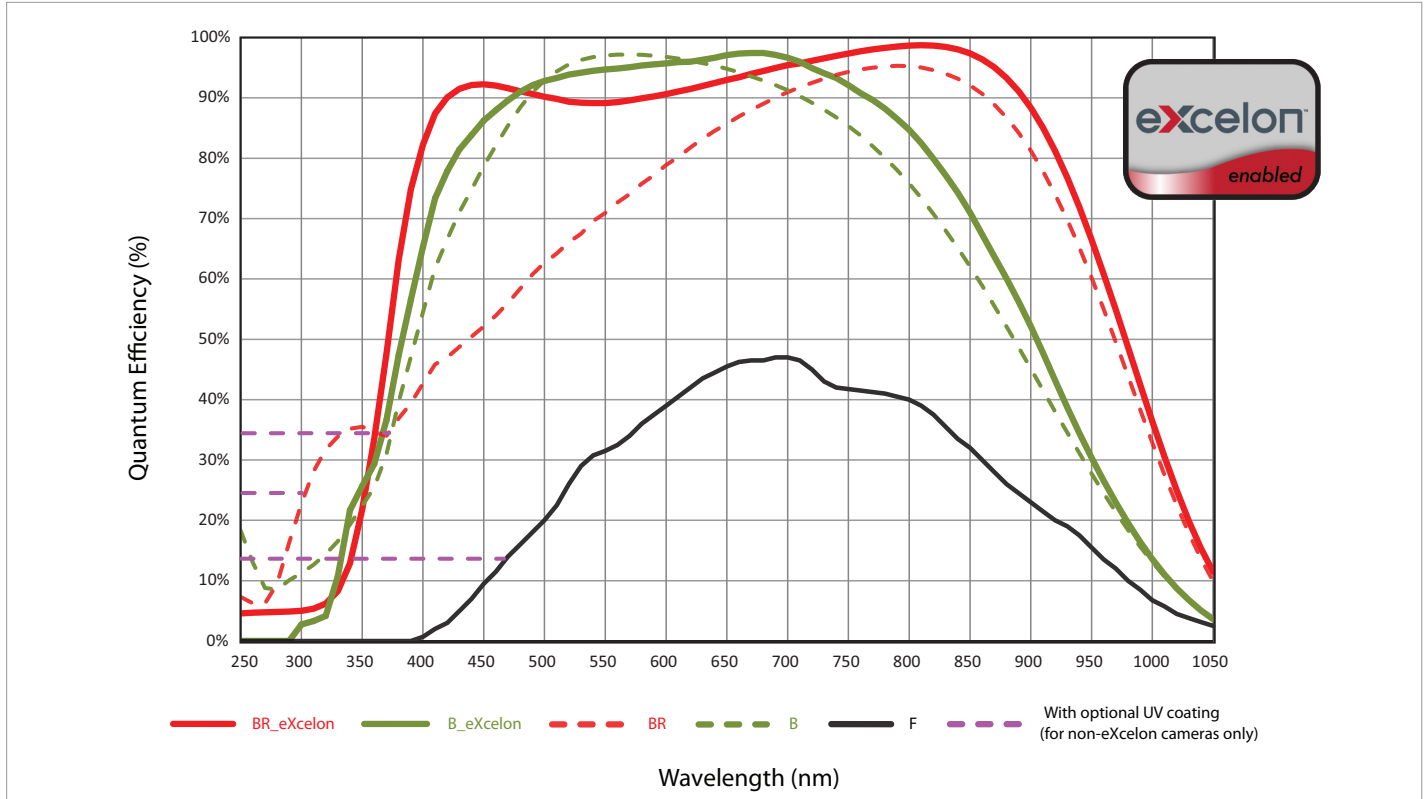

NOTE:

Graph shows typical Quantum Efficiency (QE) data measured at + 25°C. QE decreases at normal operating temperatures. For the best results for your application, please discuss the specific parameters of your experiment with your sales representative.

VACUUM WINDOW AR COATINGS

NOTES:

- Standard anti-reflection (AR) coating options shown on graph
- Designed by Acton Optics, our BBAR coating offers unmatched performance for 400 nm - 1100 nm
- Custom wedge window options and other AR coatings are also available

Contact your local sales representative for more information

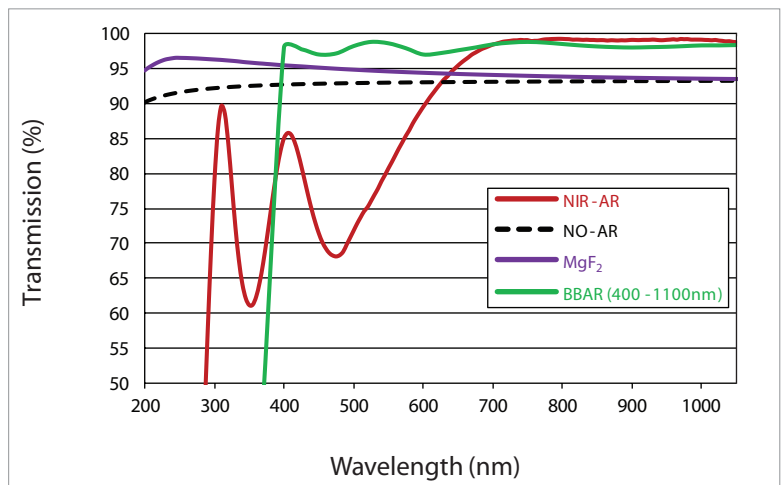

eXcelon Performance

Data taken with white light source through a monochromator, comparing etaloning performance of eXcelon vs. back-illuminated CCDs.

Back-illuminated



Back-illuminated_eXcelon

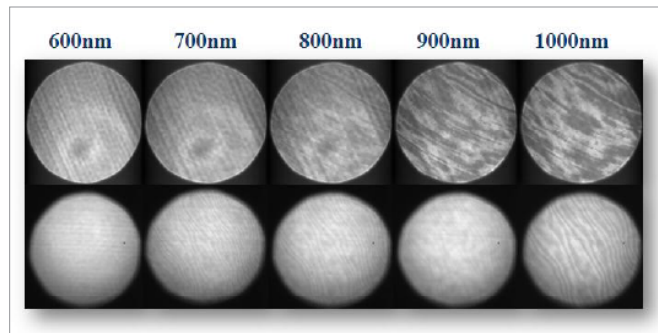

QE Improvement (B_eXcelon vs. B)

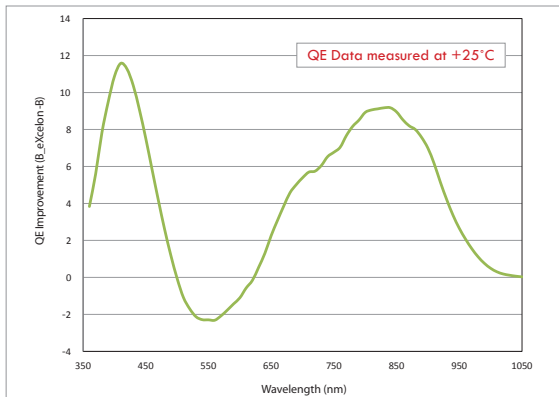

B_eXcelon provides superior QE over the standard back illuminated ("B") version in the UV-NIR range.

Etalon Oscillations (B_eXcelon vs. B)

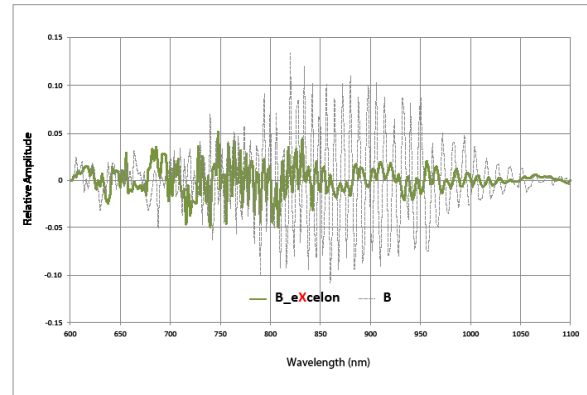

B_eXcelon provides significantly lower etaloning (unwanted fringes) compared to standard back illuminated ("B") version.

QE Improvement (BR_eXcelon vs. BR)

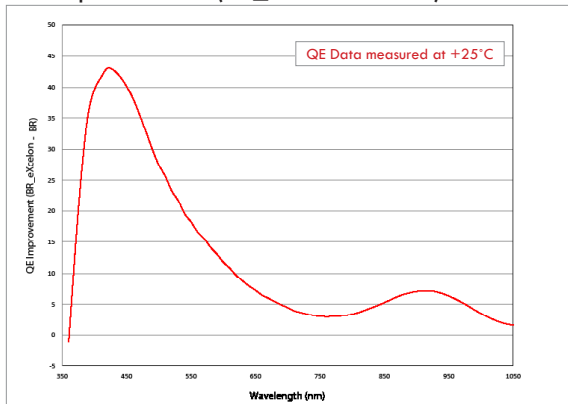

BR_eXcelon provides superior QE over standard back illuminated deep depletion ("BR") version over the entire UV-NIR range.

Etalon Oscillations (BR_eXcelon vs. BR)

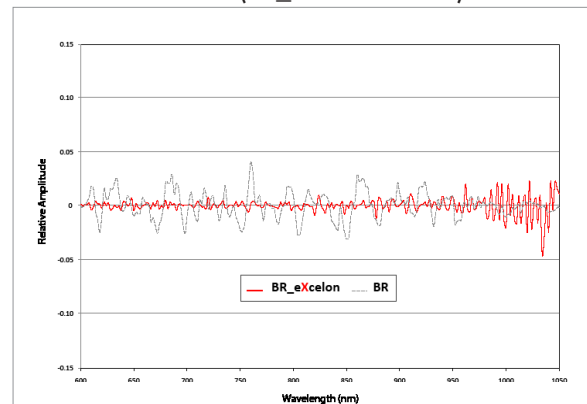

BR_eXcelon eliminates much of the residual etaloning observed in the standard back-illuminated deep depletion ("BR") version.

PyLoN with 40 mm shutter

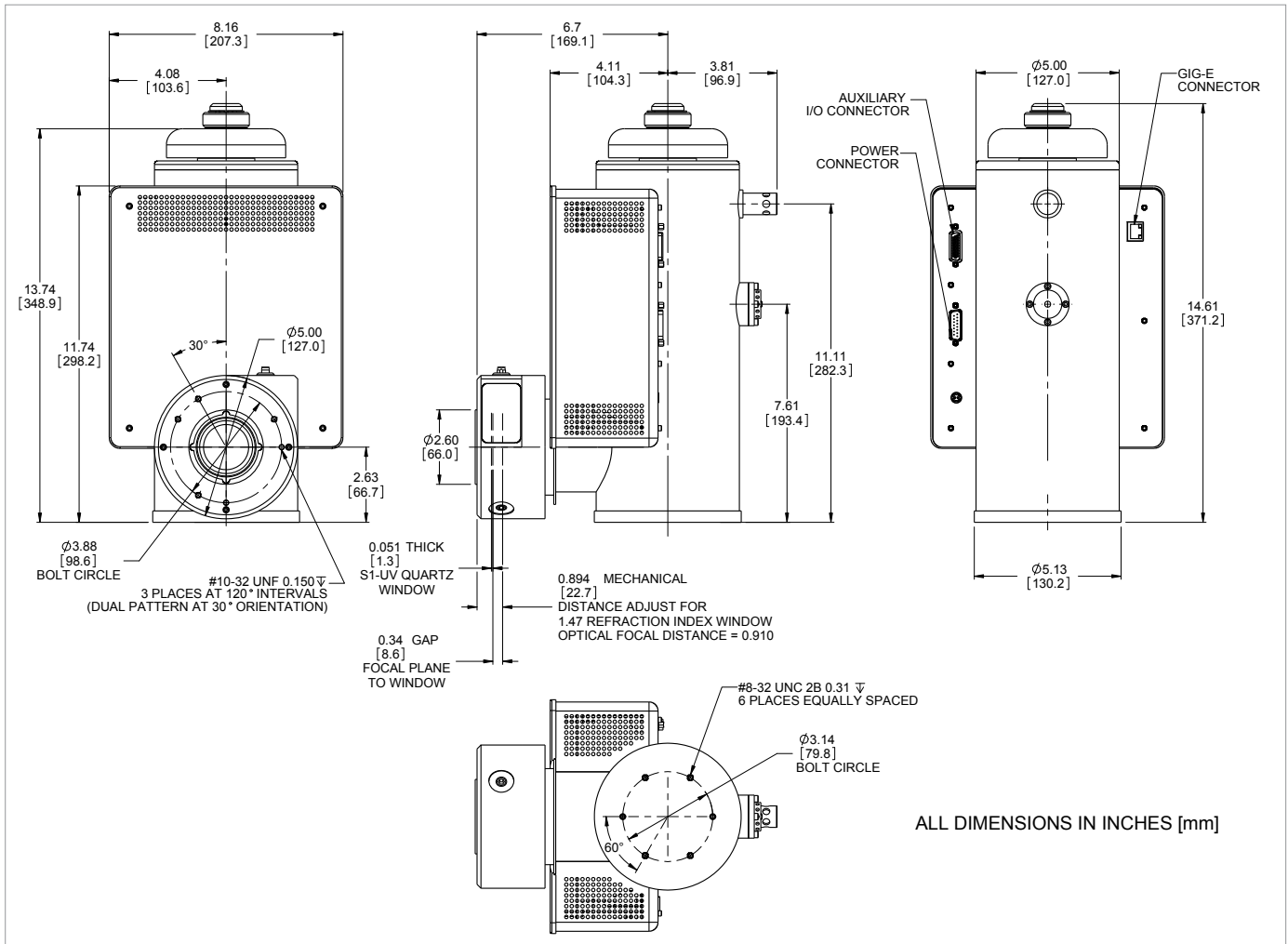

PyLoN without shutter

